



Exceptional Stones of Architectural Quality

Resource for professionals



WILLKI.CA/EN

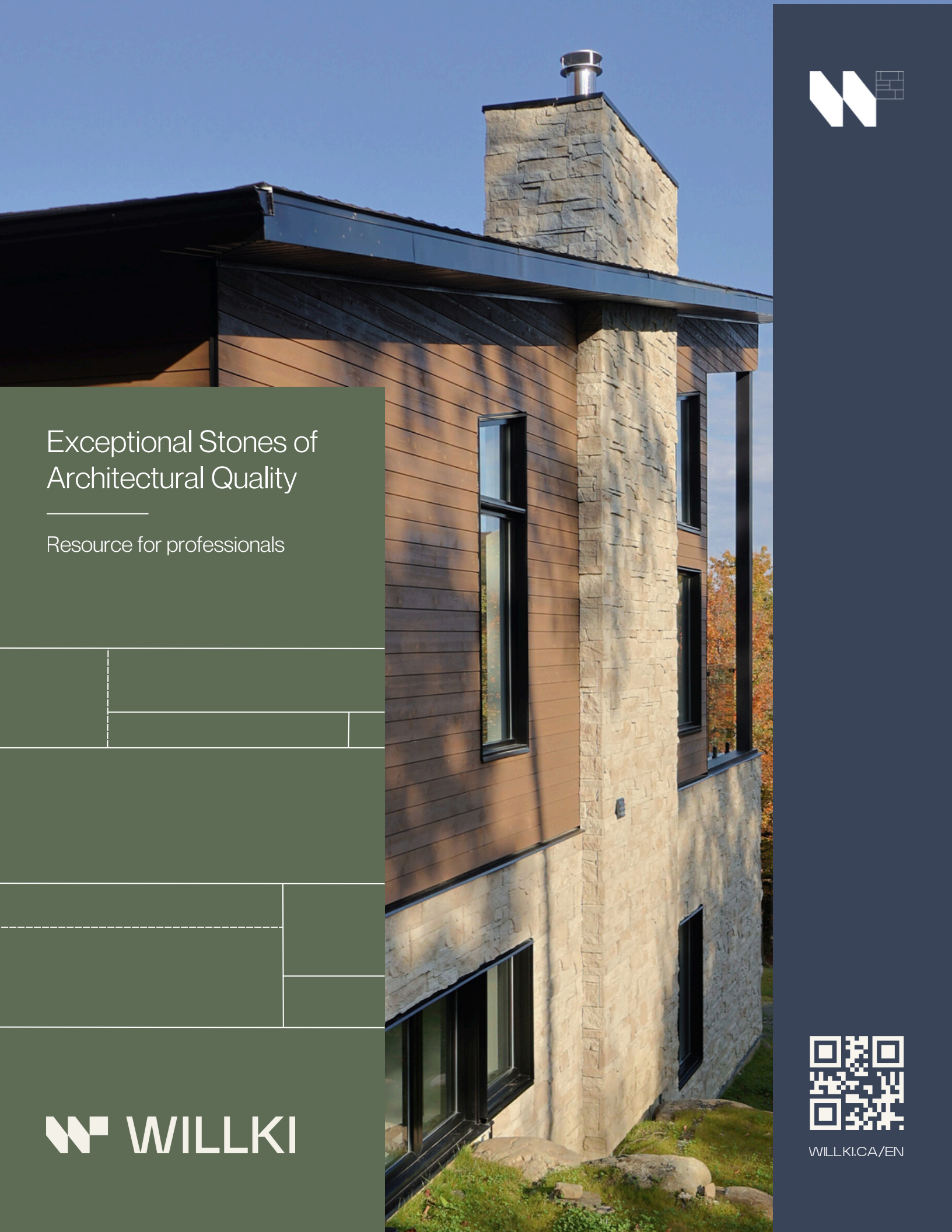



TABLE OF CONTENTS



Inspiration.....	4
Characteristics.....	13
Collections.....	14
Accessories.....	16
Installation.....	18
• Section Details.....	19
Before/After.....	20
Creative Ideas.....	24
• Indoor Fireplace.....	25
• Shed/Garage.....	26
Contests.....	27
Resources and contacts.....	28

With the CLIPS acronym, remember the features that make the Willki architectural stone system unique and versatile.

Corners are integrated

- Only 1 sku, colour match guaranteed

Lightweight

- 30% lighter than regular concrete, eco-friendly (> 70% recycled materials)

Installation on most substrates

- Indoors, outdoors, on most substrates, 12 months a year

Panels are reversible

- Groove for anchor keys on top and bottom of panels, reduces waste

System of anchor keys - EziKi

- Creates an air space behind the panel, favors ventilation and moisture management

INSPIRATION

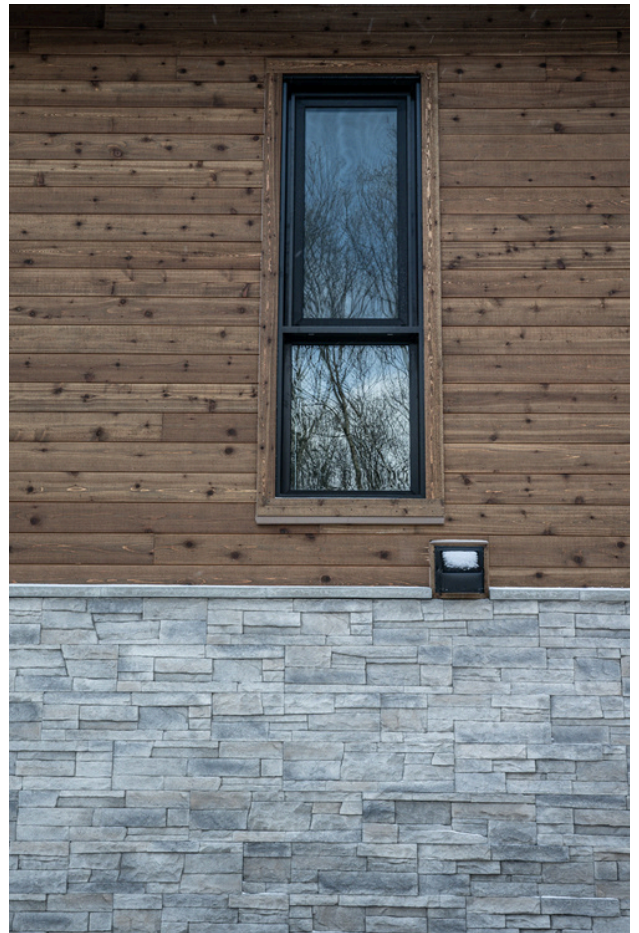
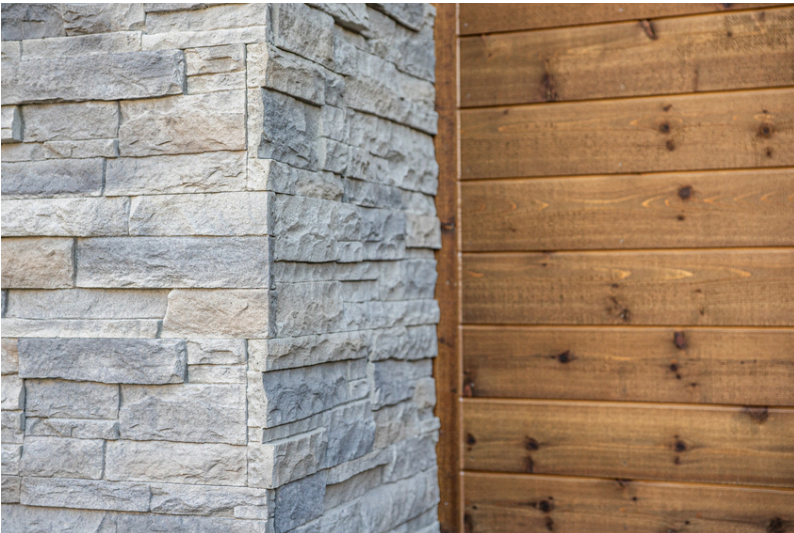



Arbor Granite

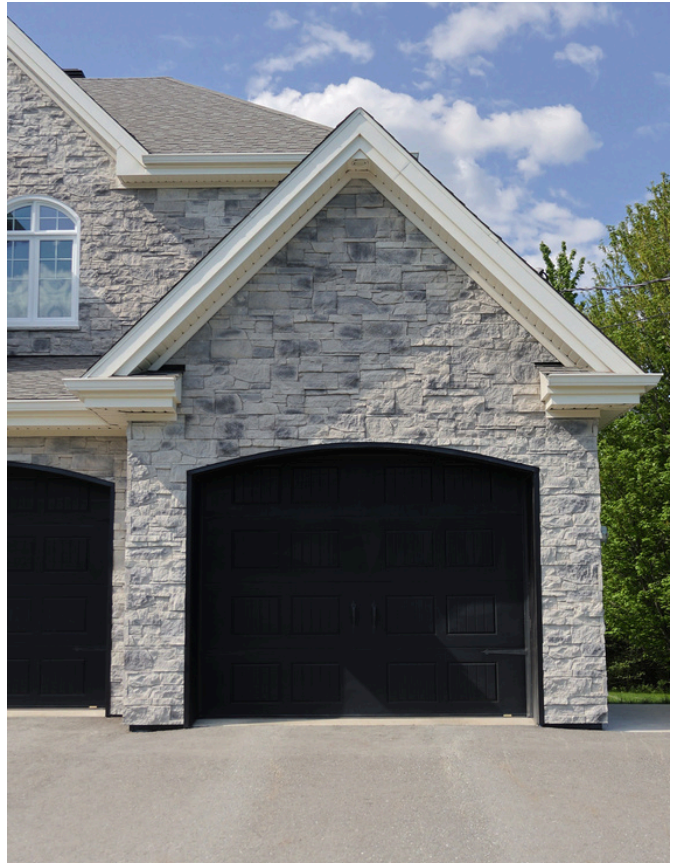

Arbor Granite

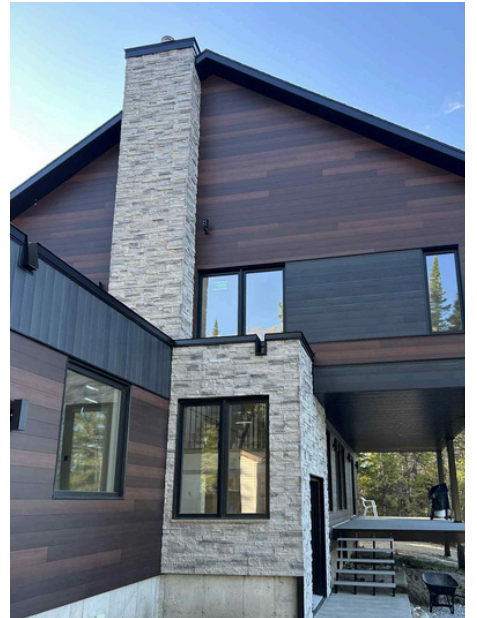
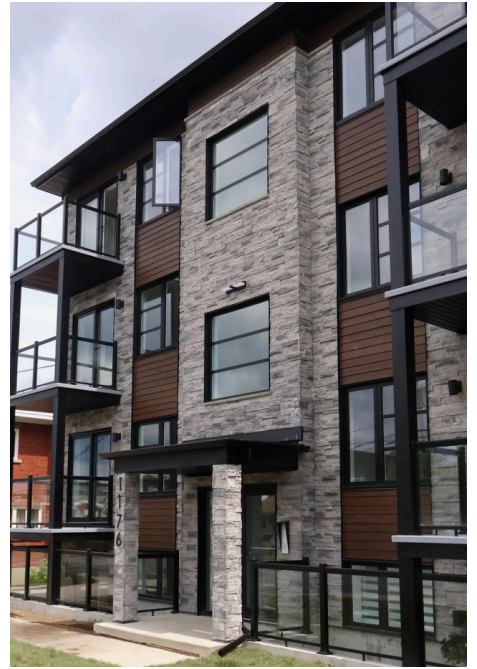



Arbor Pearl



Arbor Obsidian



Arbor Umbra



Vallis Jasper



Vallis Coal

CHARACTERISTICS

↗ Versatile

- Installs both indoors and outdoors
- Installs on most substrates, year-round
- Does not require a footing or lintel
- Integrated Corners
 - No additional corner pieces needed
 - Same panel makes inside and outside corners
 - Exposed textured ends for wall/column corners
 - Guaranteed colour match



↗ Reversible panels

- Groove for anchor keys is found on the top and bottom of each panel
- Allows reuse of cut pieces at different locations on the project, reducing waste to less than 5% and providing greater application versatility
- Minimizes waste when installing stone on a gable

↗ Eco-responsible

- Lightweight concrete composed of over 70% recycled materials

↗ High-end look

- Panels screwed at a 45° downward angle: allow for a tight fit to minimize the appearance of horizontal joints
- Beveled ends: ensure perfect contact between the front faces of the panels, reducing the appearance of vertical joints

↗ Durable

- 50-year limited transferable warranty
- Integrated colour: will not fade over time

↗ Dimensions: 32 in x 9 in x 2 in

Area: 2 square feet

Weight: 12 lbs / sq.ft.

↗ EziKi anchor key system

- Creates an air space behind the panel (0.5 in / 12 mm) ensuring ventilation and moisture management

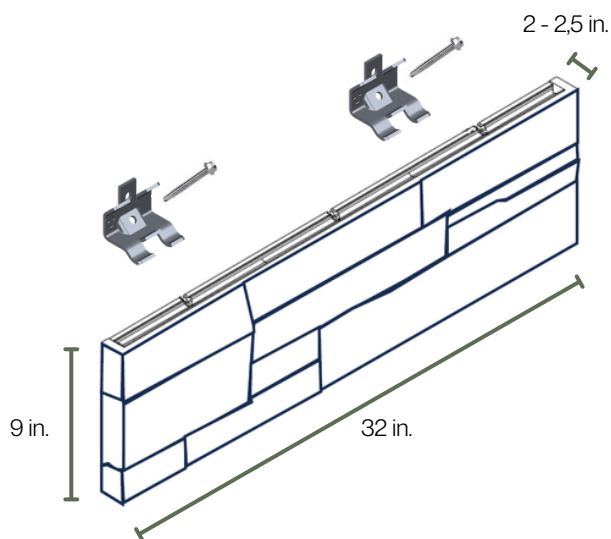

COLLECTIONS

ARBOR

Inspired by traditional fieldstone, the Arbor profile showcases large, irregular stones and pronounced depth, creating a rustic and warm aesthetic with timeless natural character.

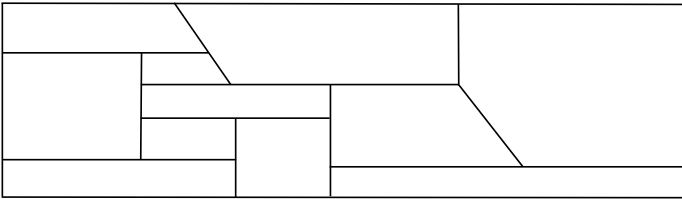

Umbra



Obsidian



Granite



Pearl





VALLIS

The Vallis profile embodies contemporary elegance. Defined by sleek, elongated stones and clean lines, it creates a refined, structured look, perfect for modern projects, both indoors and outdoors.

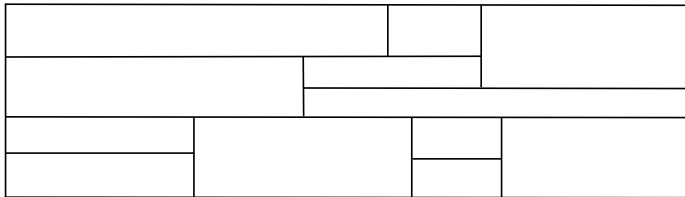

Pebble



Platinum



Gabbro



Jasper



Coal



ACCESSORIES

For a flawless, cohesive finish, Willki offers a range of carefully designed accessories that integrate seamlessly with our screw-mounted stone panels, whatever your project may be.

Transition Sill

Facilitates the transition between the stone wall and another siding of choice.



Window Sill

Allows a harmonious finish under the windows.



Finishing Trim

Offers a possibility to outline the openings such as doors and windows. Is also used to finish the sides of a facade installation.



Electrical Box

Allows the installation of an electrical outlet or a switch.



Light Box

Allows the installation of a lamp.



Universal Boxes (4 and 6 in.)

Used for a better finish around dryer outlets, vents, air intakes, and others.

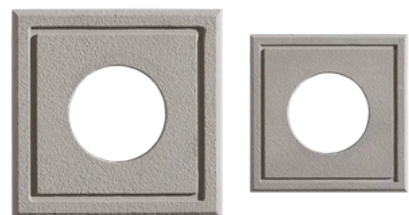

AVAILABLE COLOURS

NERO



GRIGIO

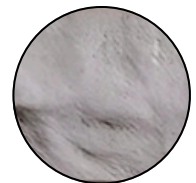

CREMA





Recommended Colour Match

NERO

- Arbor Obsidian
- Arbor Granite
- Vallis Coal
- Vallis Platinum
- Vallis Gabbro

GRIGIO

- Arbor Umbra
- Arbor Granite
- Vallis Pebble
- Vallis Platinum
- Vallis Gabbro

CREMA

- Arbor Pearl
- Vallis Pebble
- Vallis Jasper



INSTALLATION

Installation in 3 easy steps:

1. Install the starter strip



2. Stack the panels, place 2 Eziki anchor keys in the groove of each panel, then screw



3. Finish with accessories (sills, trims and finishing plates)



See the installation guide and videos

↗ Full library of installation videos on our website and YouTube channel

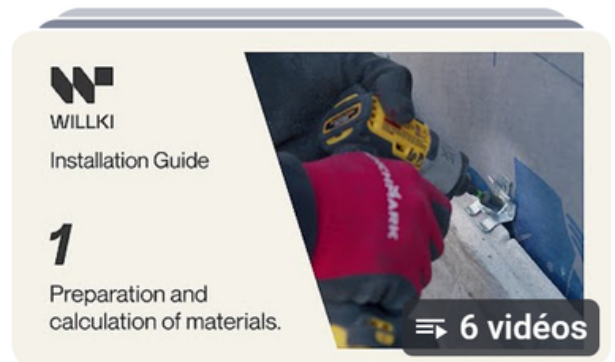

WILLKI Installation Guide



SECTION DETAILS

Finishing around windows and doors

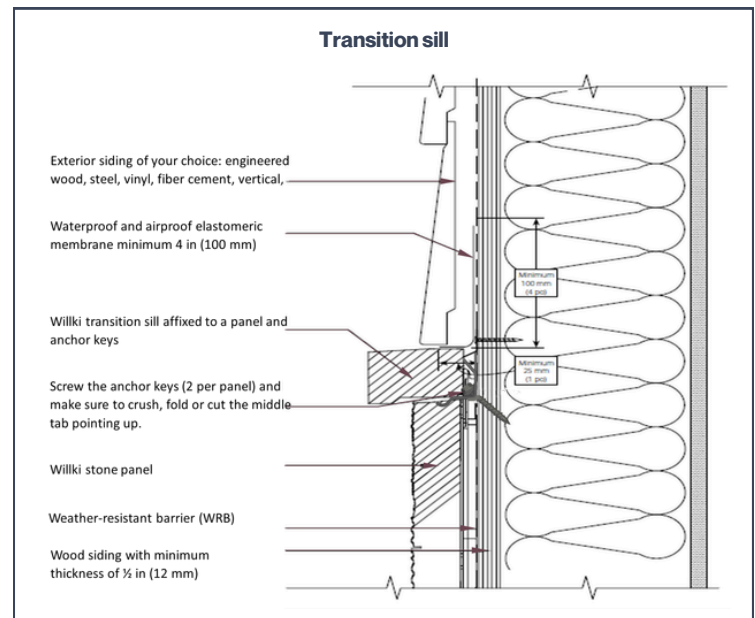
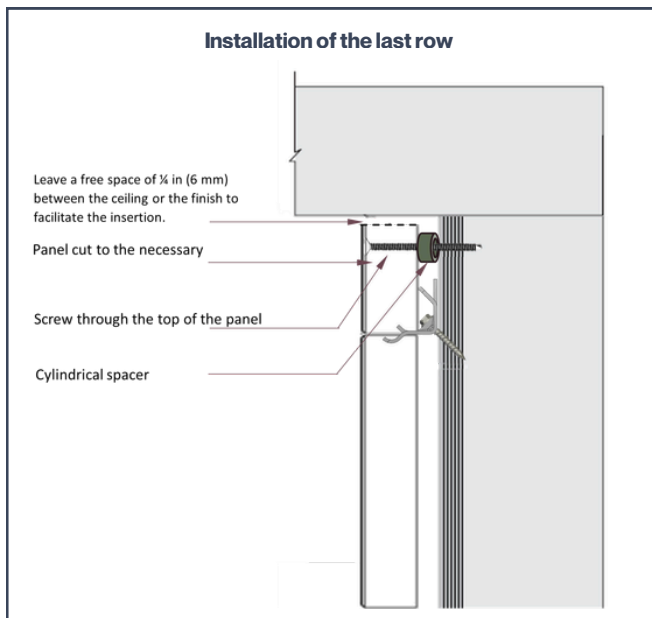
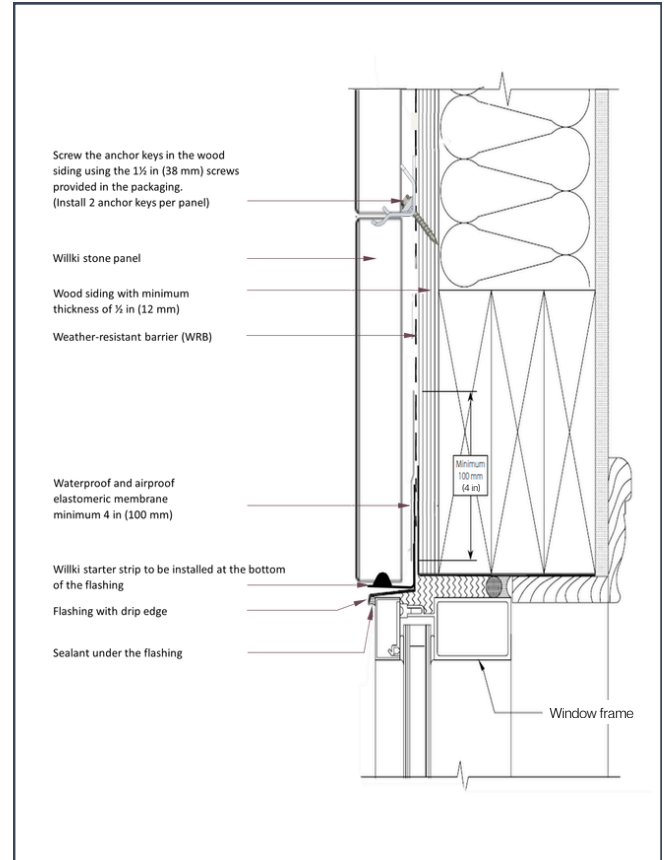
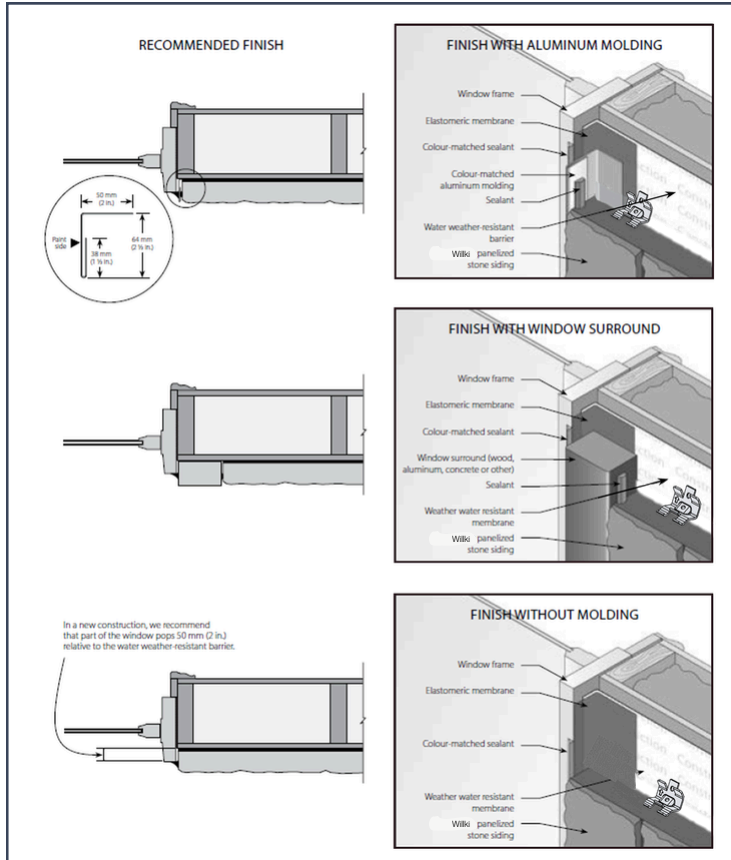

BEFORE / AFTER

Willki screw-on stone panels are ideal for renovations, as they allow you to transform a home quickly and easily while providing a natural stone look at a lower cost. Without the need for a structural foundation, footing or lintel, they are suitable for a variety of projects, both indoors and outdoors. Willki stone meets the needs of homeowners looking for a practical and modern solution to enhance the appearance of their home.

BEFORE



AFTER



Vallis Platinum



Vallis Gabbro



Vallis Gabbro



Arbor Granite



Vallis Platinum

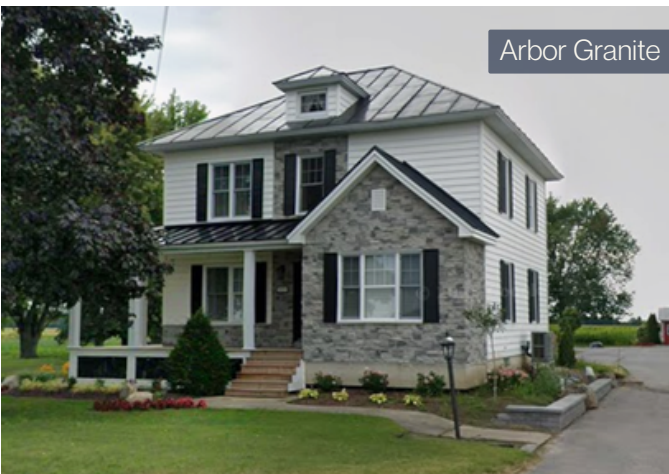



Vallis Gabbro



Vallis Platinum



Vallis Platinum



Vallis Pebble

CREATIVE IDEAS

With Willki stone, the possibilities are endless! Whether it's to create an elegant indoor fireplace, a striking accent wall, a modern outdoor kitchen, refined columns, or to enhance the look of sheds and detached garages, Willki adapts to all your projects. Let your imagination run wild and transform your spaces with style and durability.



INDOOR FIREPLACE



SHED/GARAGE



CONTESTS

TRANSFORMATION CONTEST

Open to homeowners and builders

- Share your project for a chance to win up to \$2,500 in material reimbursement
- Eligible for new builds and renovations (before & after)
- Enter at: willki.ca/en/contest-transformation



3D RENDERING CONTEST

Open to design professionals

- Create a 3D rendering using a Willki texture for a chance to win \$1,000
- One entry per submitted rendering
- Submit to: info@willki.ca
- Download textures: willki.ca/en/toolbox



Willki
Vallis | Platinum



Willki
Arbor | Umbr



Willki
Arbor | Obsidian



RESOURCES

All these resources can be found on our website: willki.ca/en

Product Sheets

Vallis



Arbor



Installation Guide and Videos



Warranty Details and Registration



3D Textures and Other Resources



CONTACTS

Willki

15, rue de l'Atlantique
Bromont (Québec) J2L 2R3
Canada
T 450.534.1250
E info@willki.ca

Olivier Wilkie

Director of Sales
C 514.961.6546
E owilkie@willki.ca

Réjean Beaulieu

Manufacturing Agent – Atlantic Canada
C 506.426.0199
E rbeaulieu@willki.ca

Mark Corriveau

Territory Manager - Quebec
C 514.743.7530
E mcorriveau@willki.ca

Emmanuelle Morin

Marketing
C 819.452.0720
E emorin@willki.ca



Social Media